

1984 NATIONAL VIDEO FESTIVAL

(AFI)

2 CHANNELS OF VIDEO

4 CHANNELS OF AUDIO

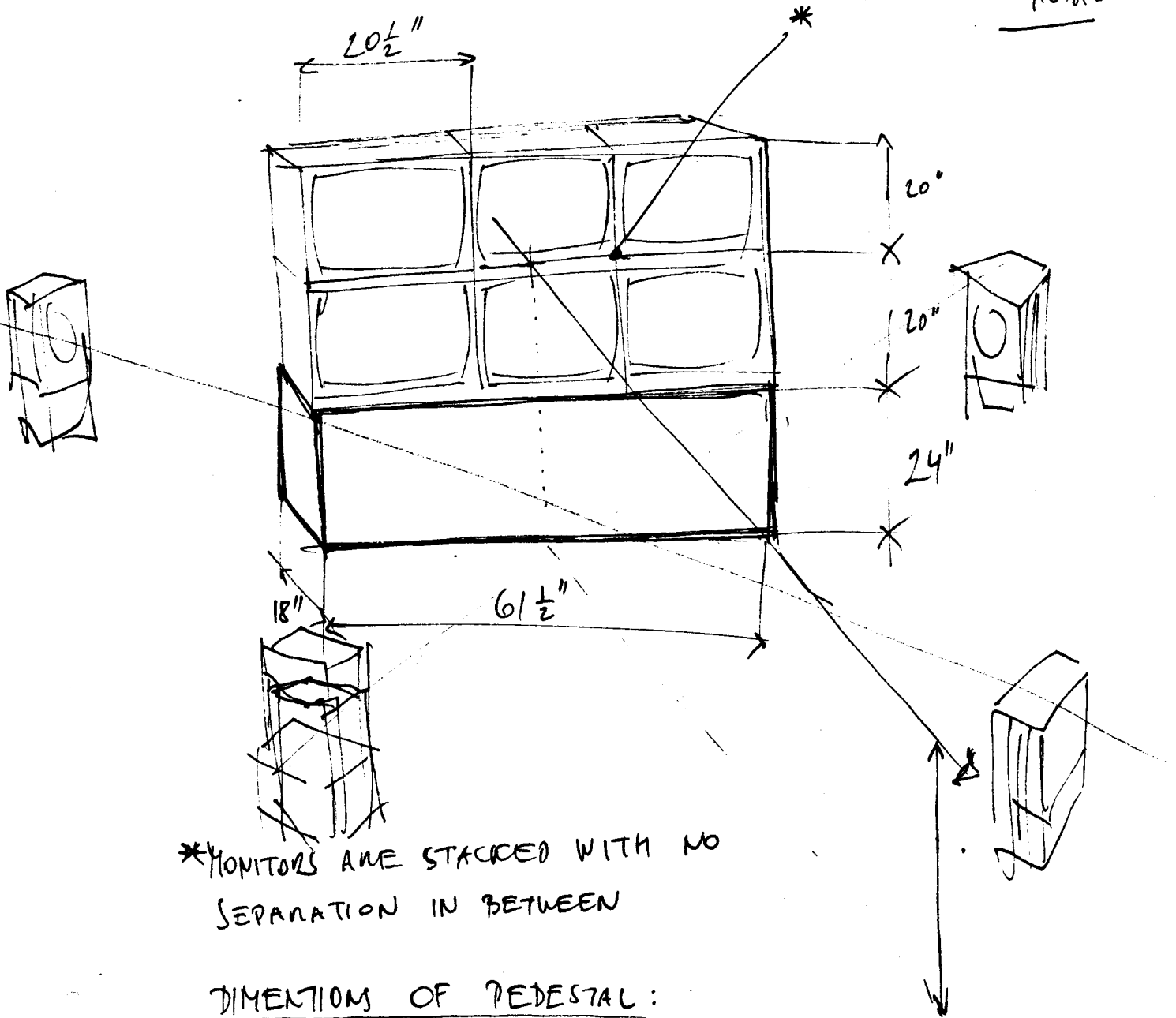

*MONITORS ARE STACKED WITH NO SEPARATION IN BETWEEN

DIMENSIONS OF PEDESTAL:

61 1/2 (W), 24" (H), 18" (D)

COLOR : BLACK OR BATTLESHIP GRAY

Rear Steina & Woody-

I am working on enlarging the installation to 48 monitors.
36 is for sure.
I'll call if I can secure more.

Steve

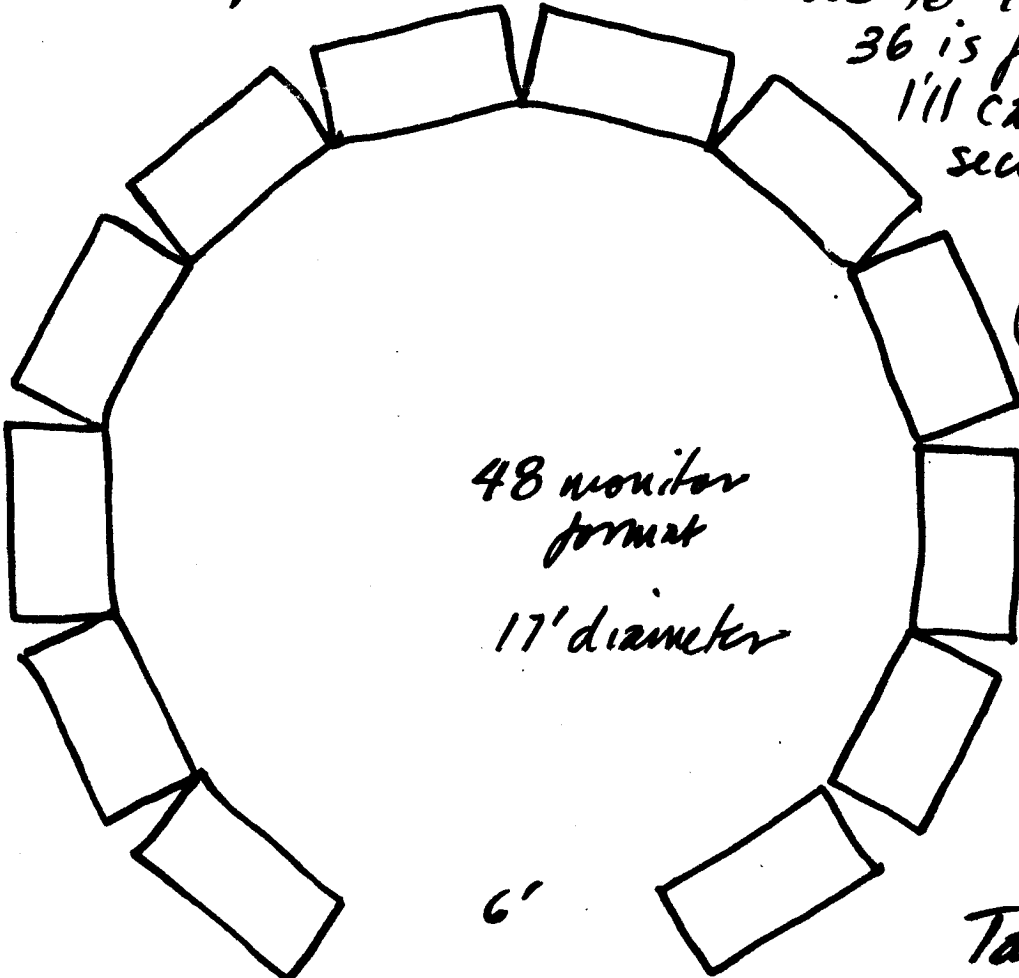

2 monitors wide
2 monitors high

Tables
2' x 4' x 42" h
draped in black

4 monitors
per table
enclosed by
seven sides
of an octagon
8' high

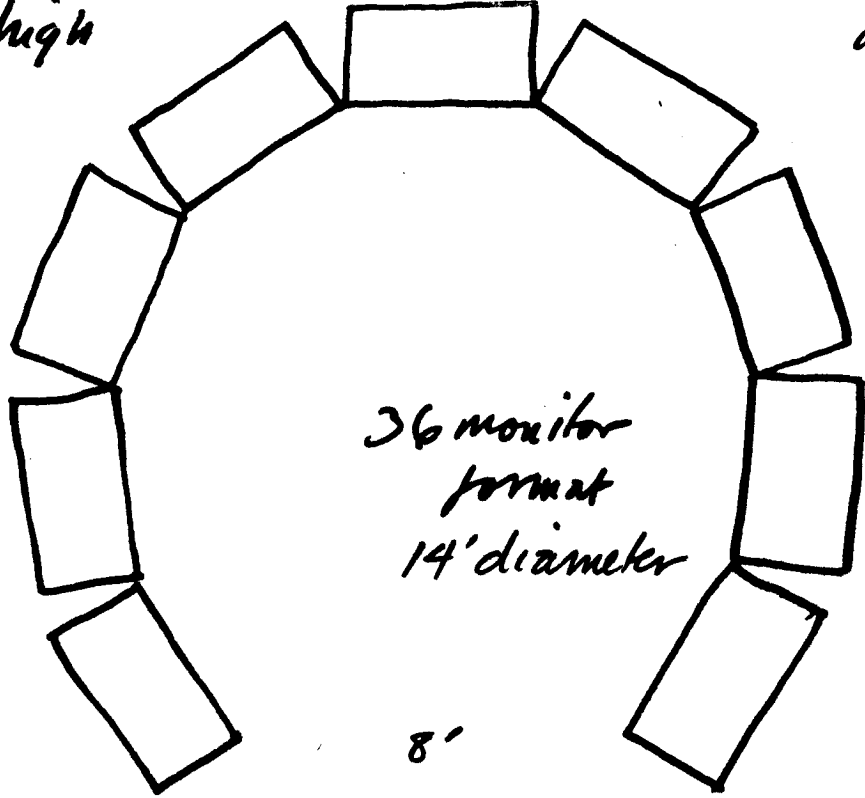

36 monitor
format
14' diameter

8'

THE WEST

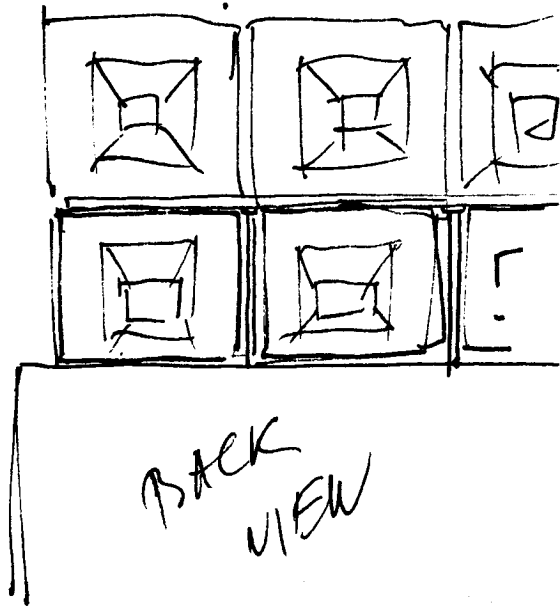
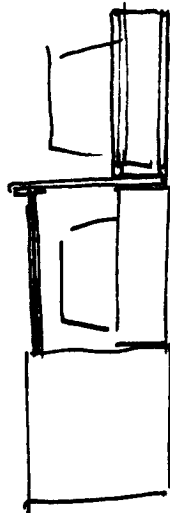
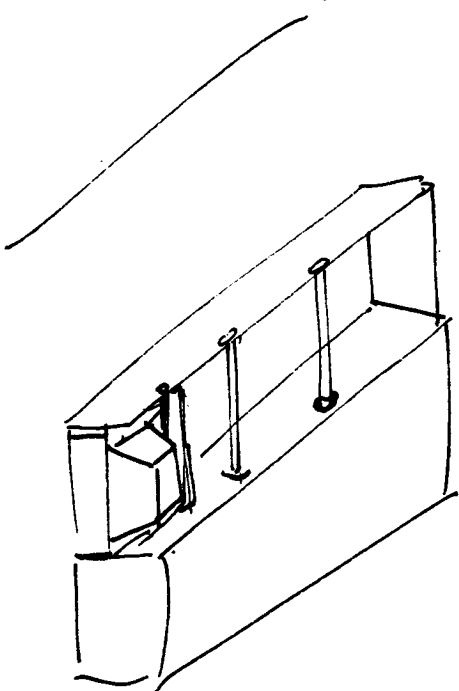
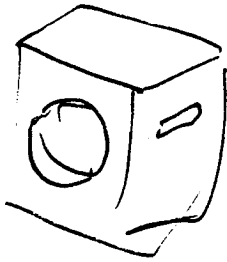
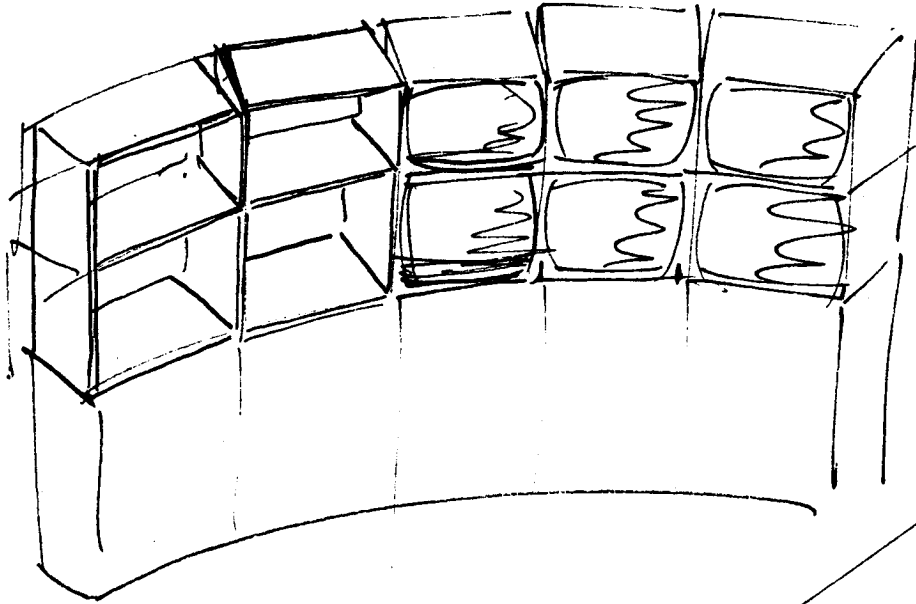

TOP

THE WEST

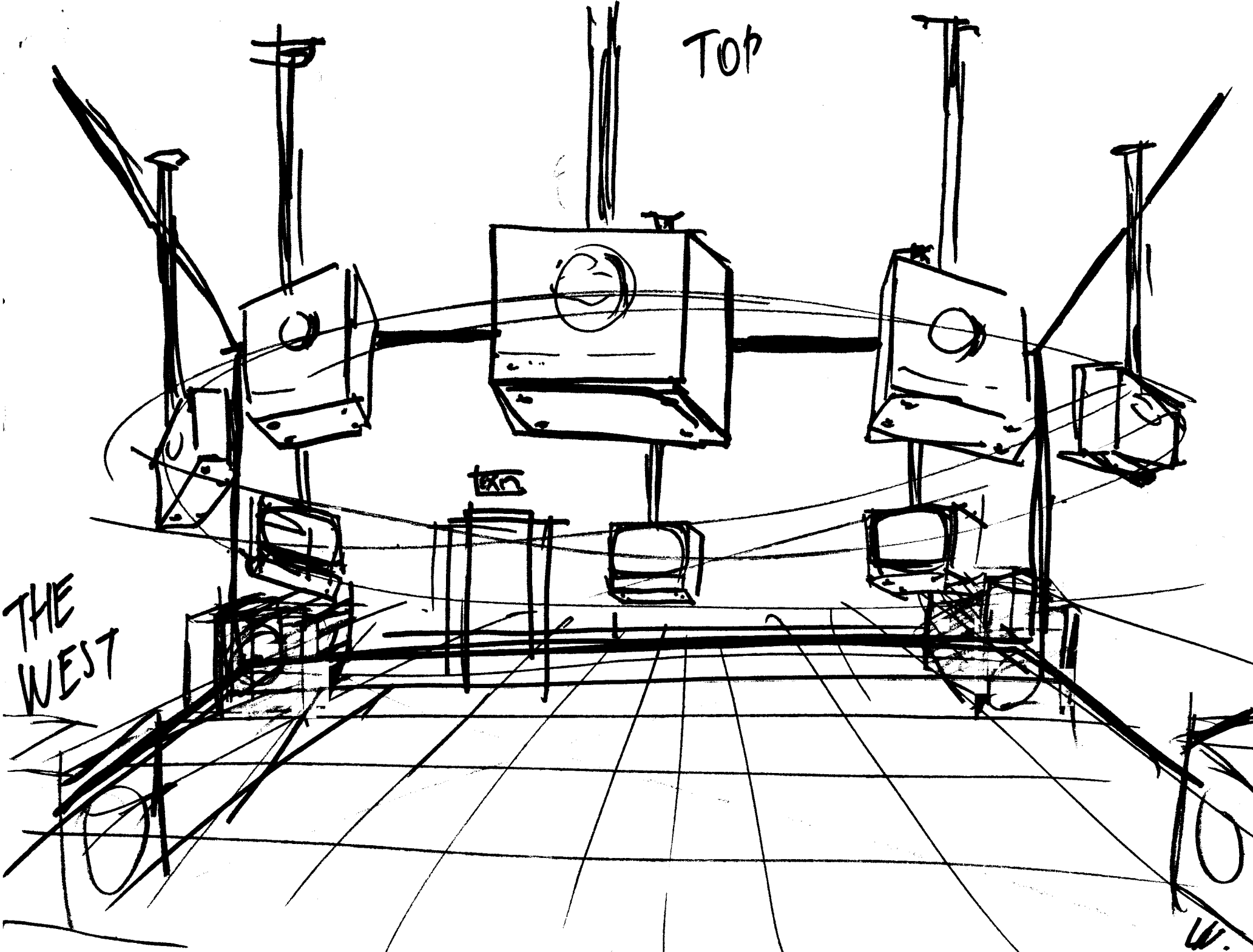

SYNCHRONIZATION

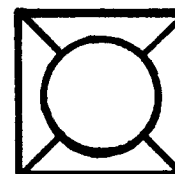
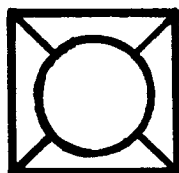
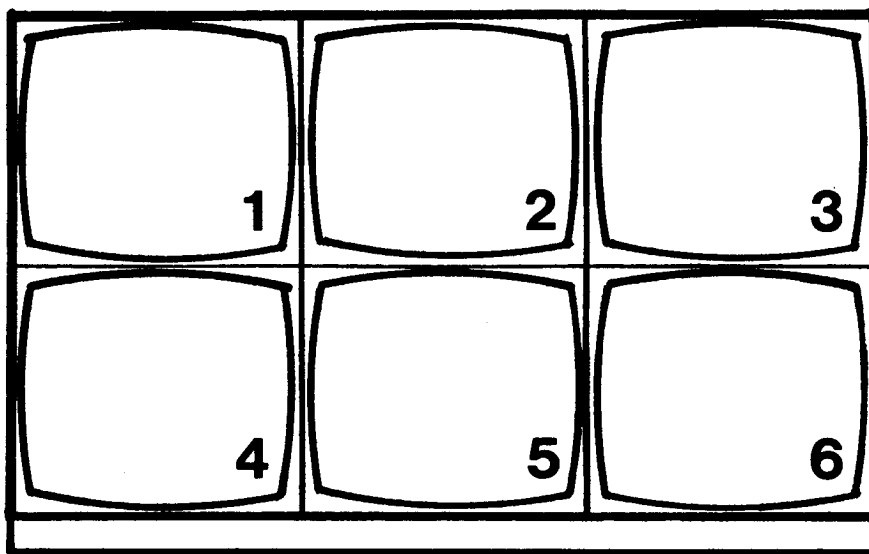
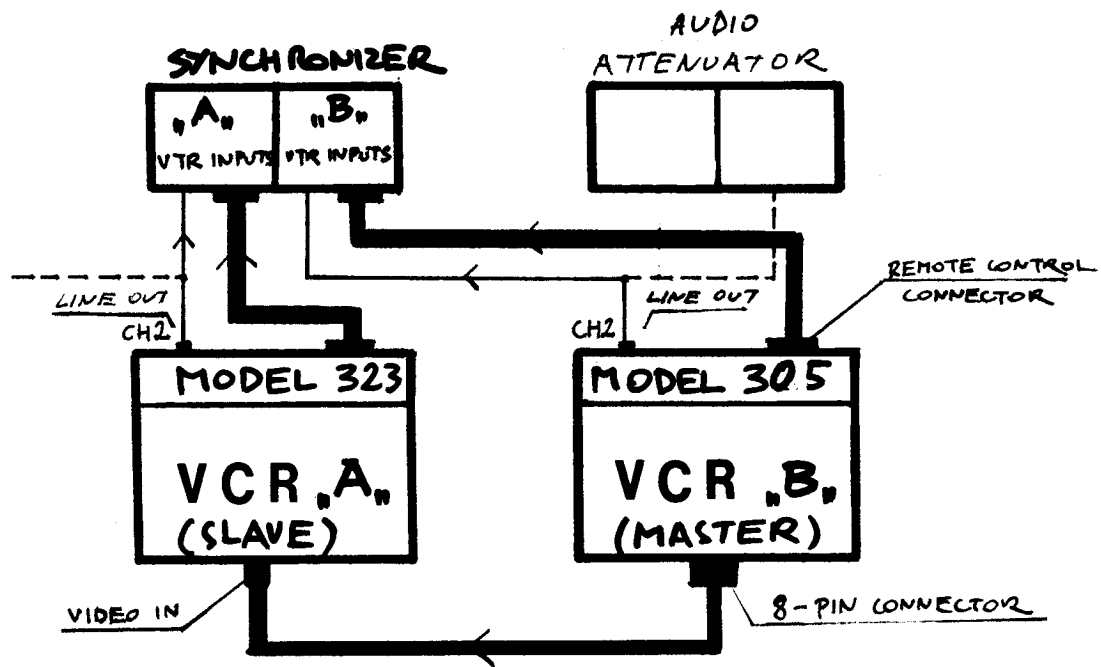

VIDEO

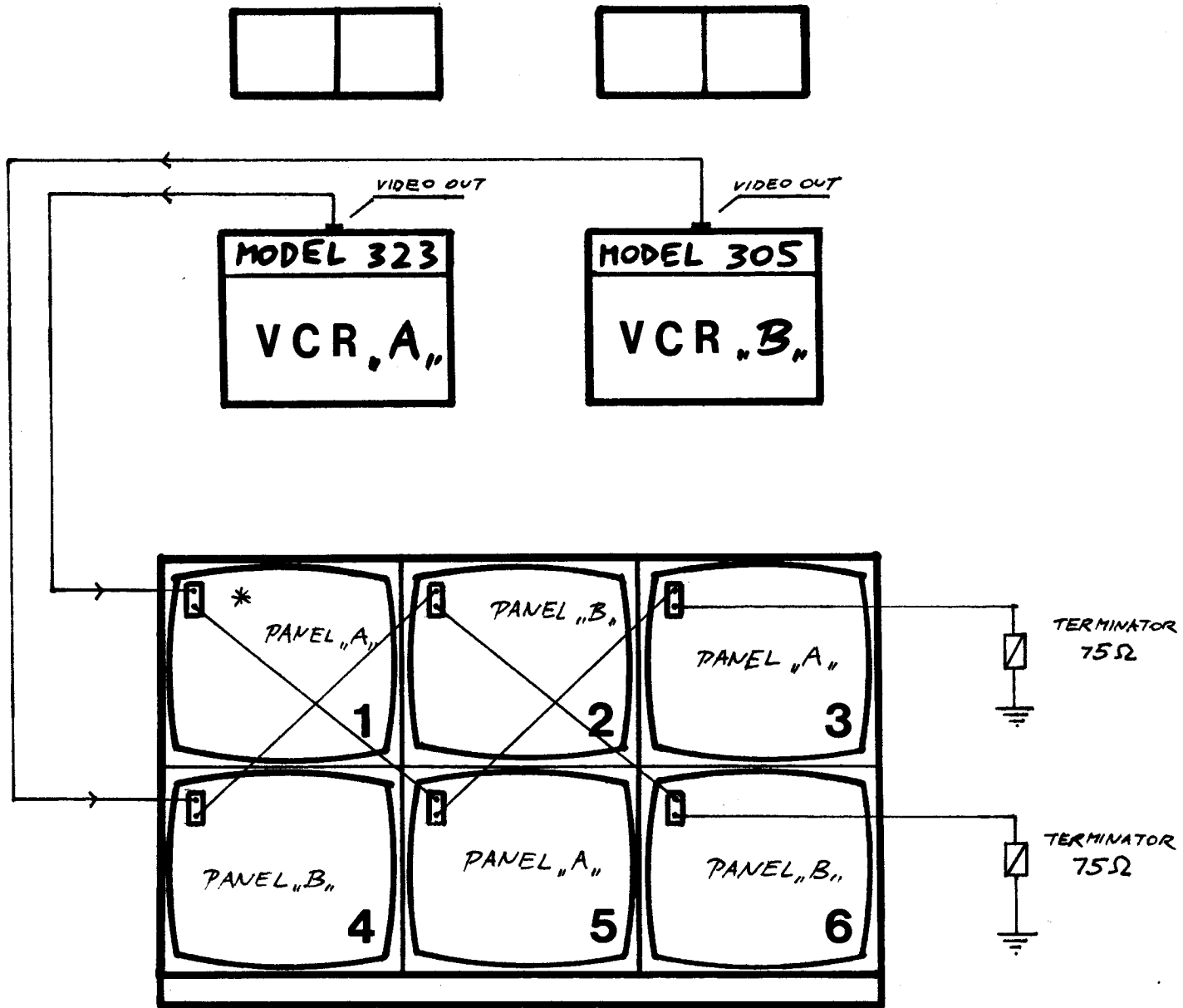

* FOR DETAILED MONITOR HOOK-UP SEE: MULTIPLE MONITOR CONNECTION

NEXT PG.

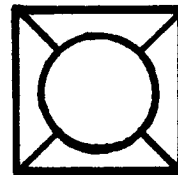
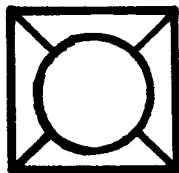

A C POWER

(GRAND TOTAL : 882W)

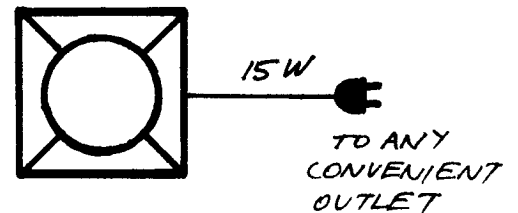
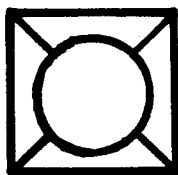
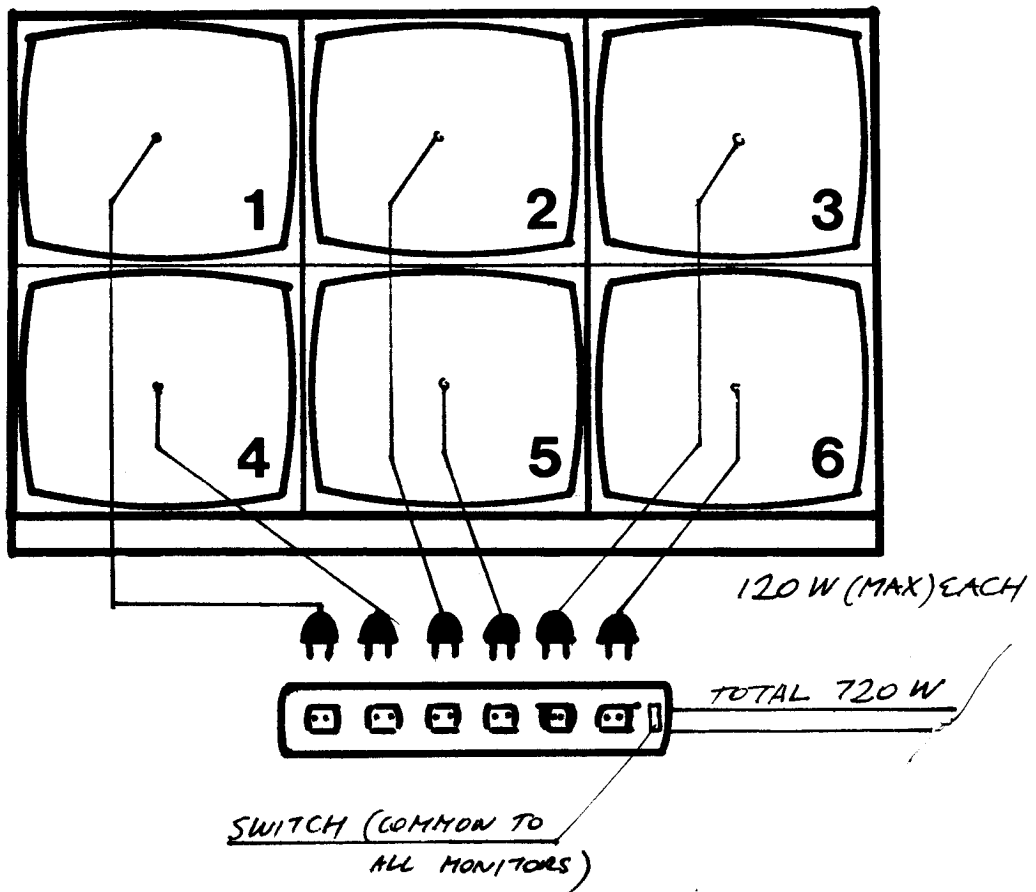
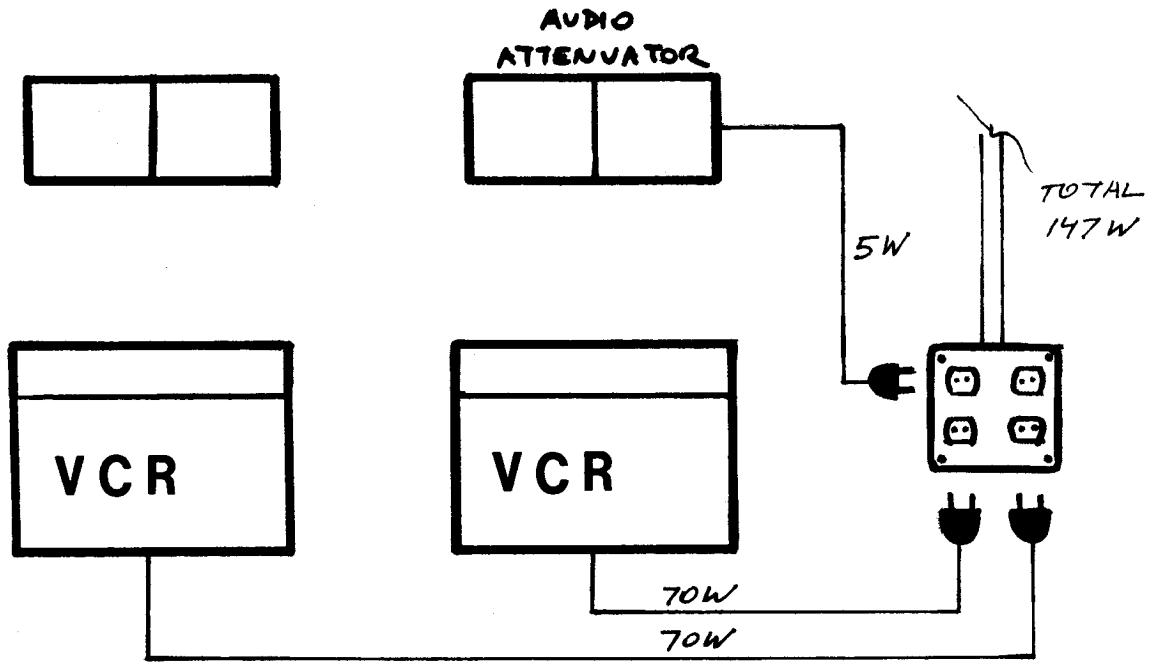

AUDIO

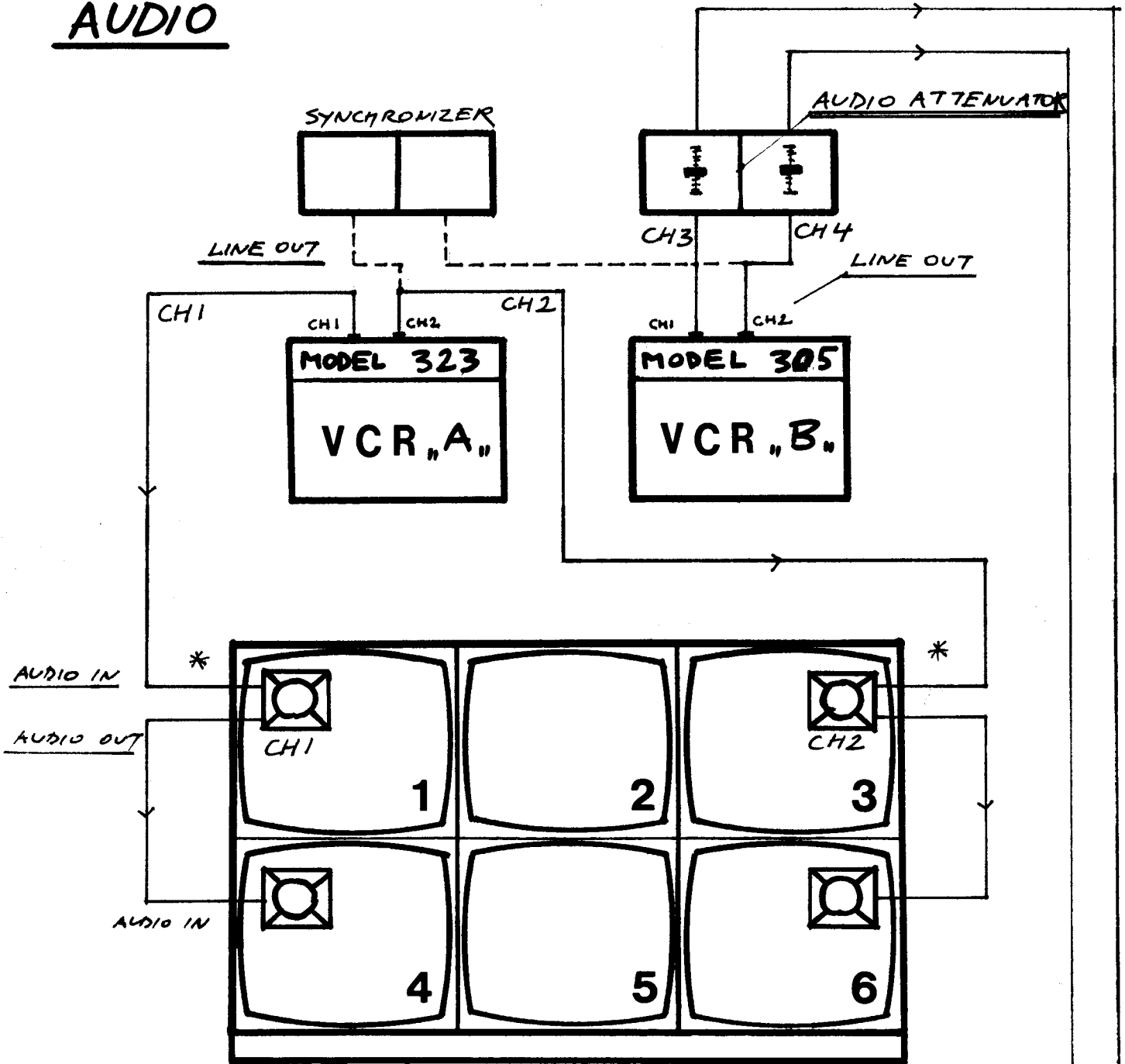

* FOR DETAILED MONITOR HOOK-UP SEE: MULTIPLE MONITOR CONNECTION

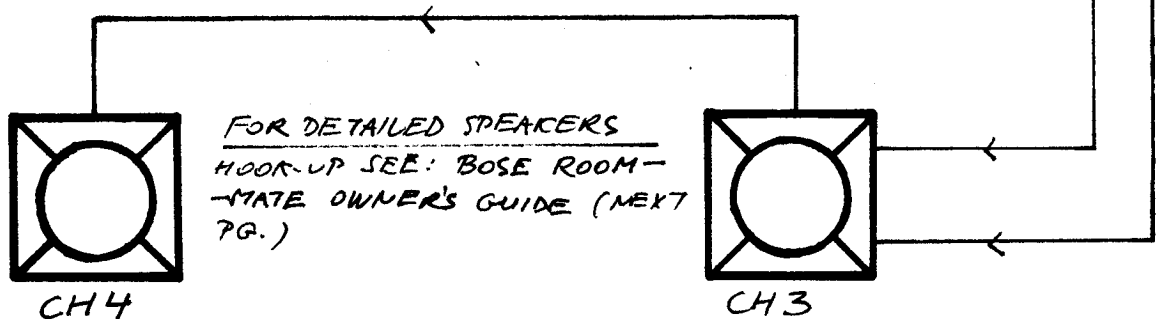

FOR DETAILED SPEAKERS
HOOK-UP SEE: BOSE ROOM-
MATE OWNER'S GUIDE (NEXT
PG.)

OFFICE

SOUND TRANSFER

1/4" = 1' SCALE

VIDEO INSTALLATION

RECEPTION

WOMEN

LIGHT BLOCK



BANNER

AFI OFFICE

ENTRY

AFI OFFICE

LIGHT BLOCK



BANNERS

FRONT DOORS

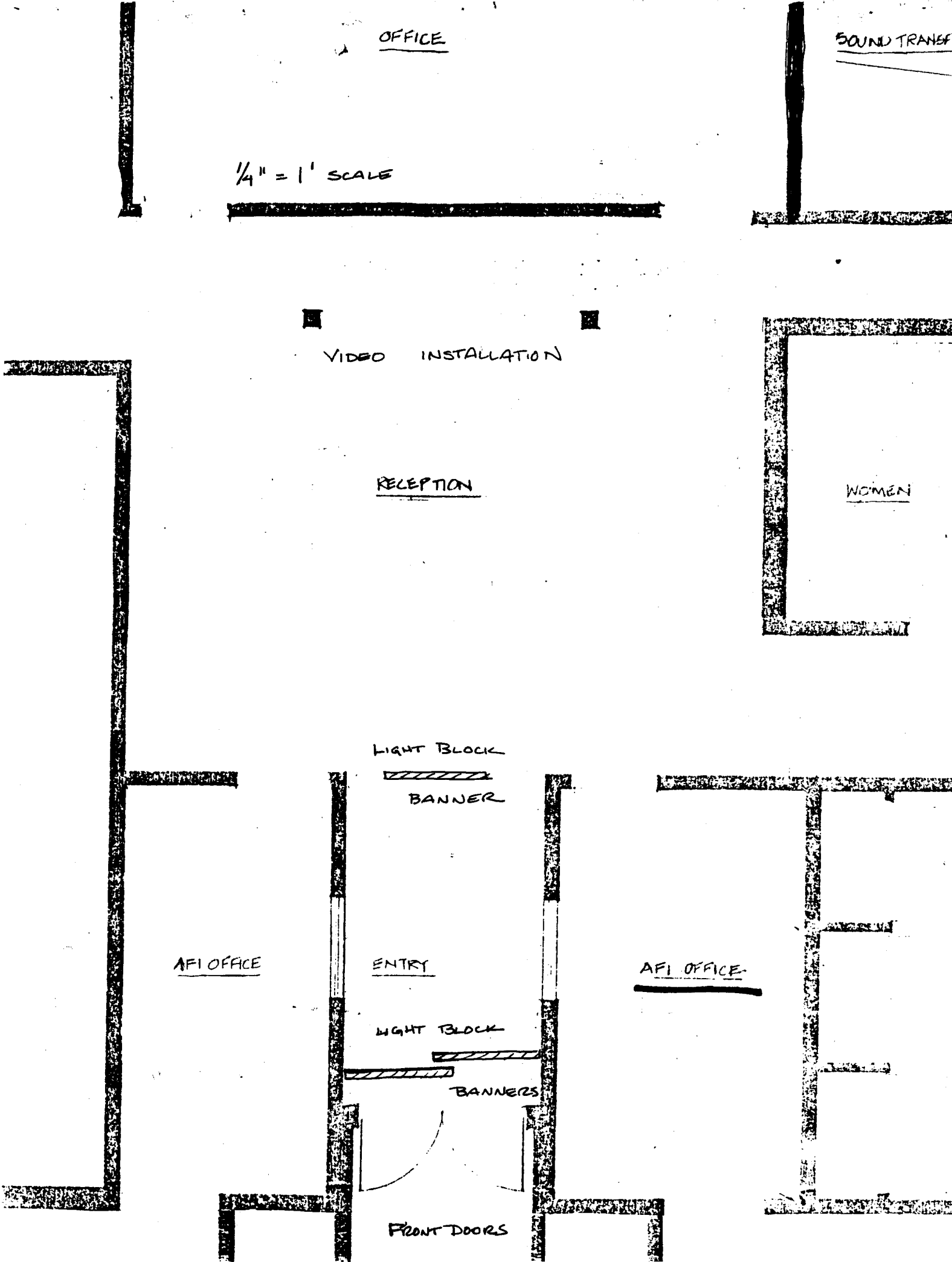

THE/VASULKAS//RT/6//BOX/100//SANTA/FE//NEW/MEXICO//87501//USA//*/THE/VASULKAS//RT/6//BOX/100//SANTA/FE//NEW/MEXICO//87501//USA//*/TH
E/VASULKAS//RT/6//BOX/100//SANTA/FE//NEW/MEXICO//87501//USA//*/THE/VASULKAS//RT/6//BOX/100//SANTA/FE//NEW/MEXICO//87501//USA//*/THE/
VASULKAS//RT/6//BOX/100//SANTA/FE//NEW/MEXICO//87501//USA//*/THE/VASULKAS//RT/6//BOX/100//SANTA/FE//NEW/MEXICO//87501//USA//*/THE/VA
SULKAS//RT/6//BOX/100//SANTA/FE//NEW/MEXICO//87501//USA//*/THE/VASULKAS//RT/6//BOX/100//SANTA/FE//NEW/MEXICO//87501//USA//*/THE/VASU

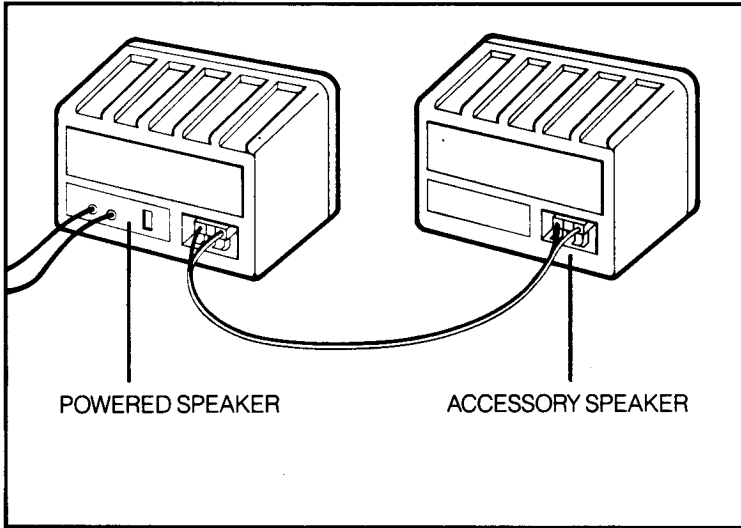

FIGURE 1
While the two enclosures look alike, they are different. The POWERED (LEFT) speaker also includes a stereo power amplifier.

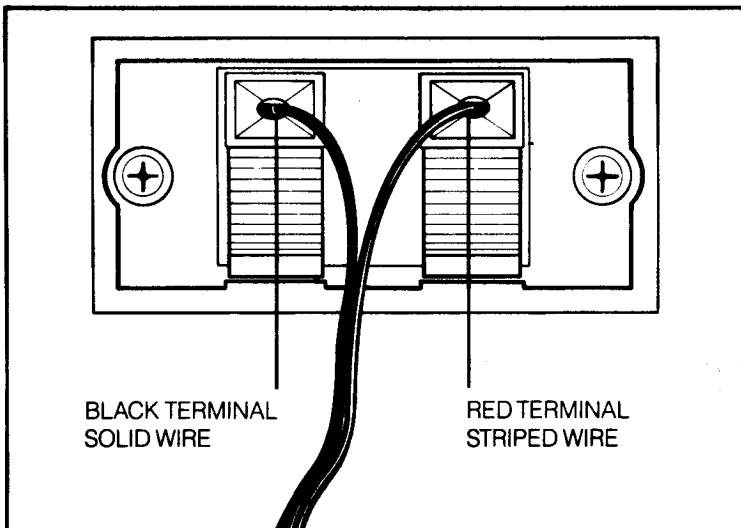

FIGURE 2
Make sure to connect the wire between the speakers red to red and black to black.

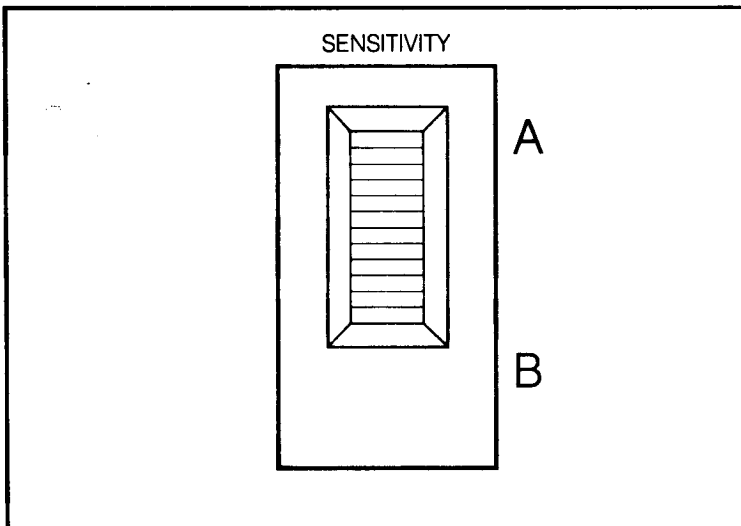
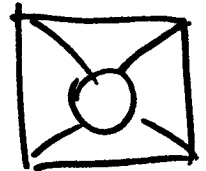
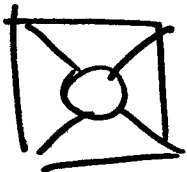
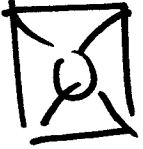
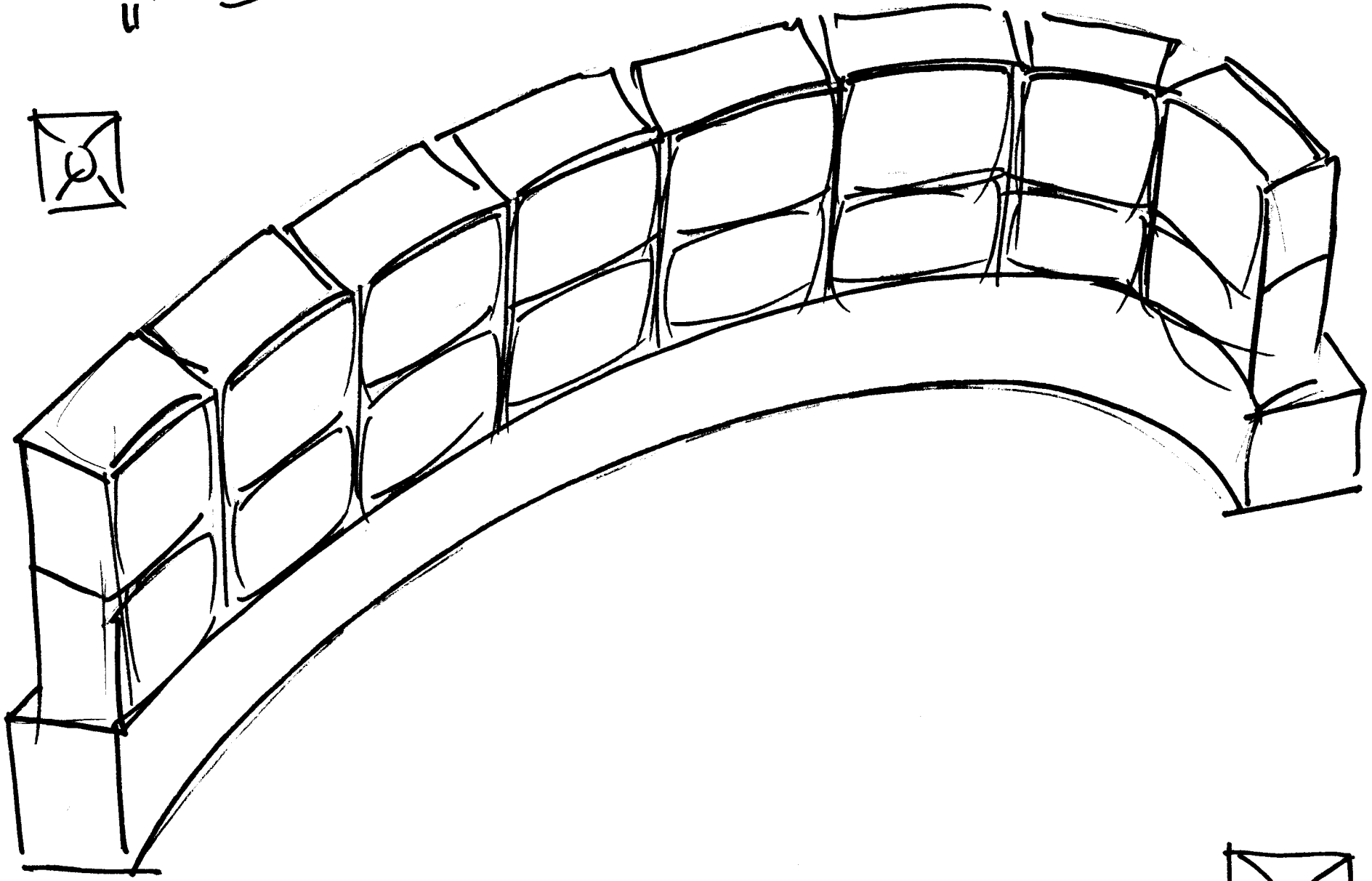

FIGURE 6
Use the SENSITIVITY switch on the POWERED speaker to match the RoomMate system

"TUE WEST", (INVEX96)

8 冊 x 2



THE VASULKAS

"THE WEST" 4

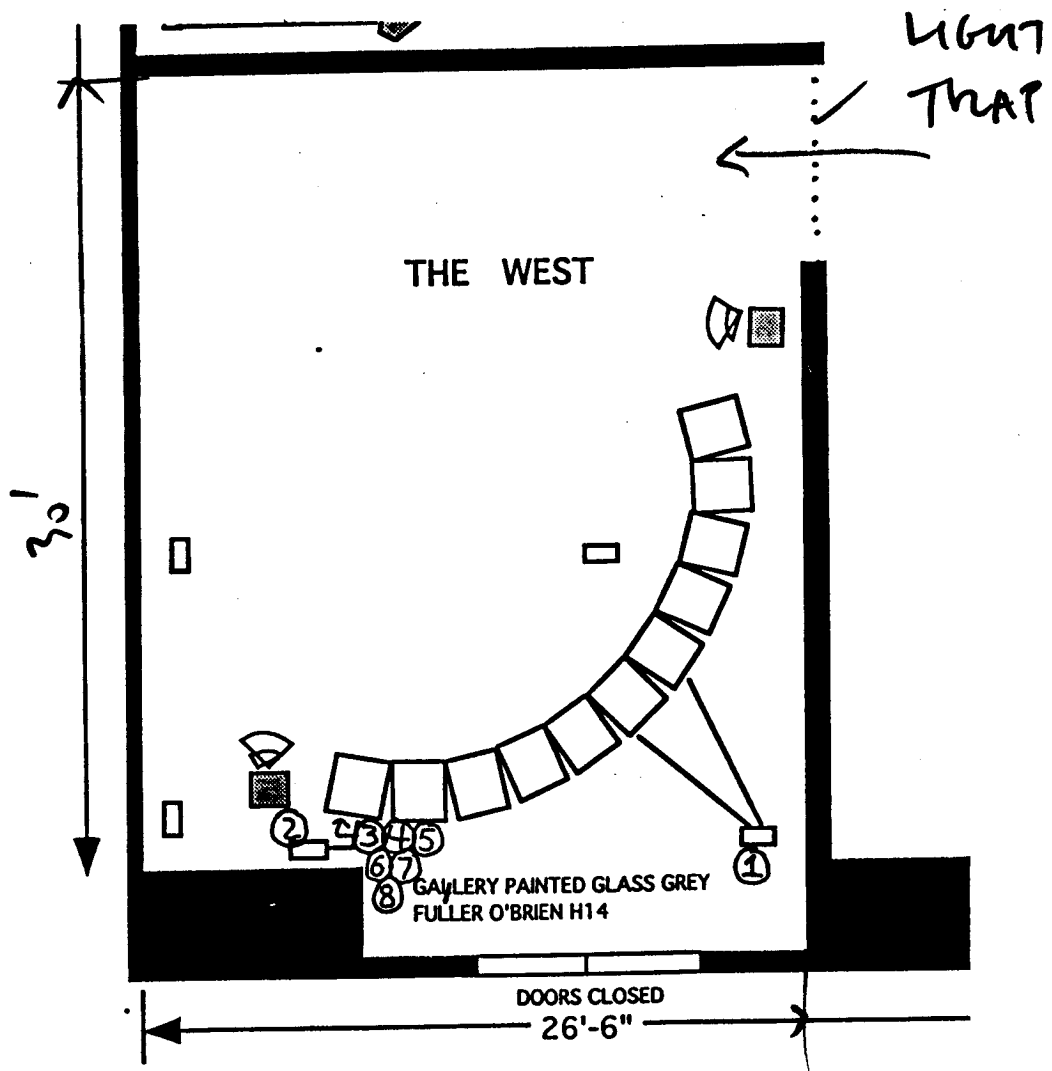

THE WEST

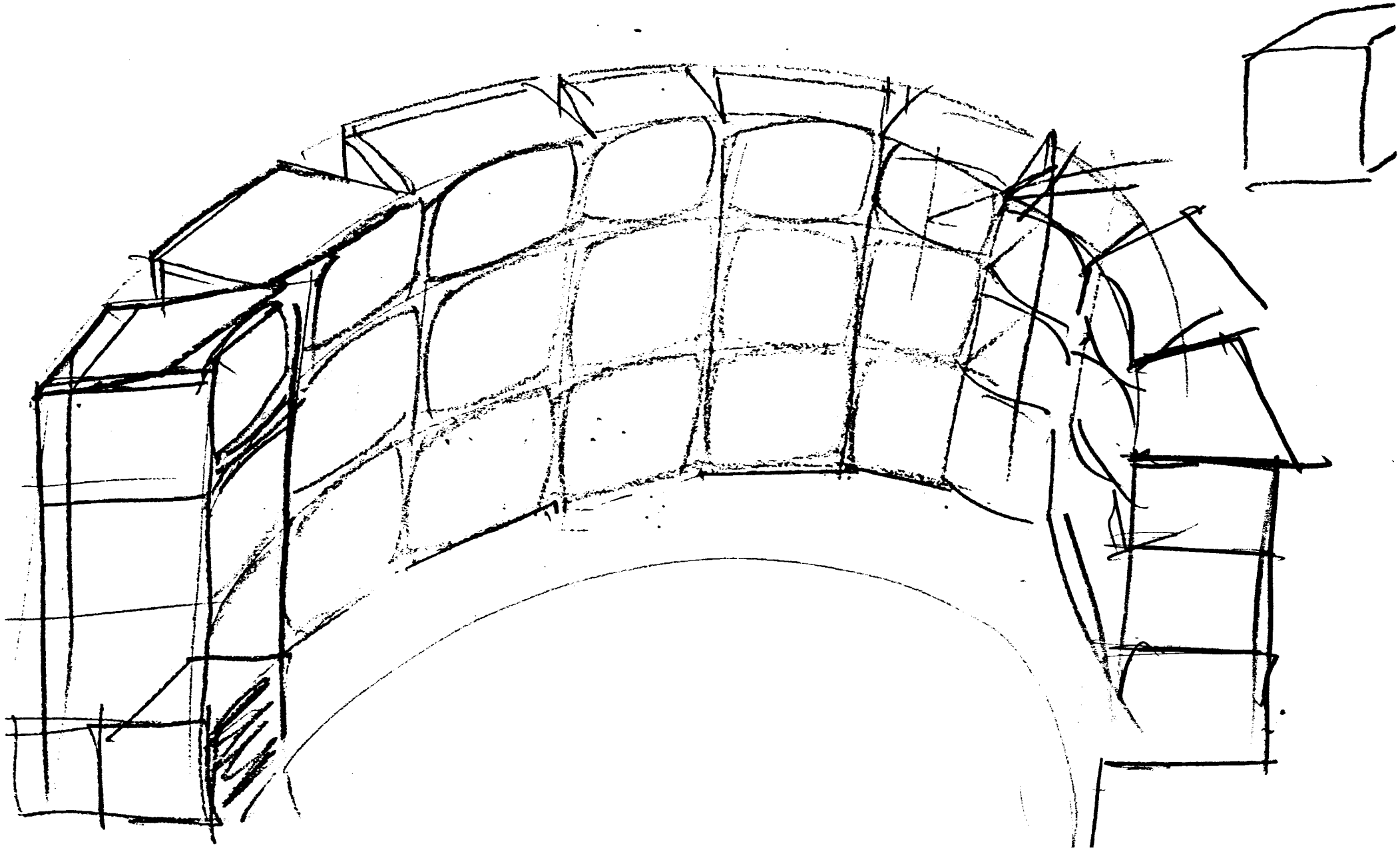

THE WEST - (ONE OF THE TWO SEMI CIRCLES)

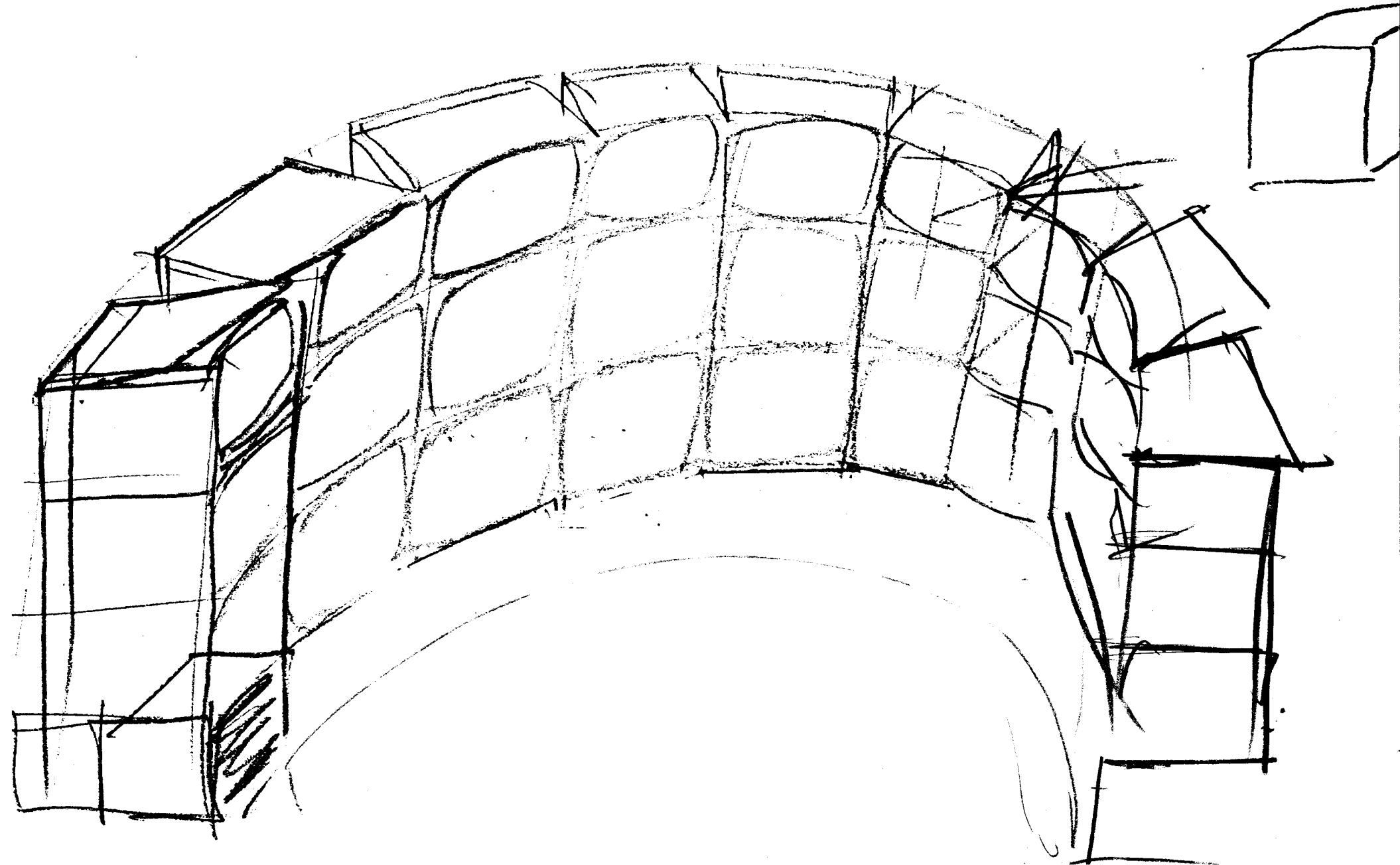

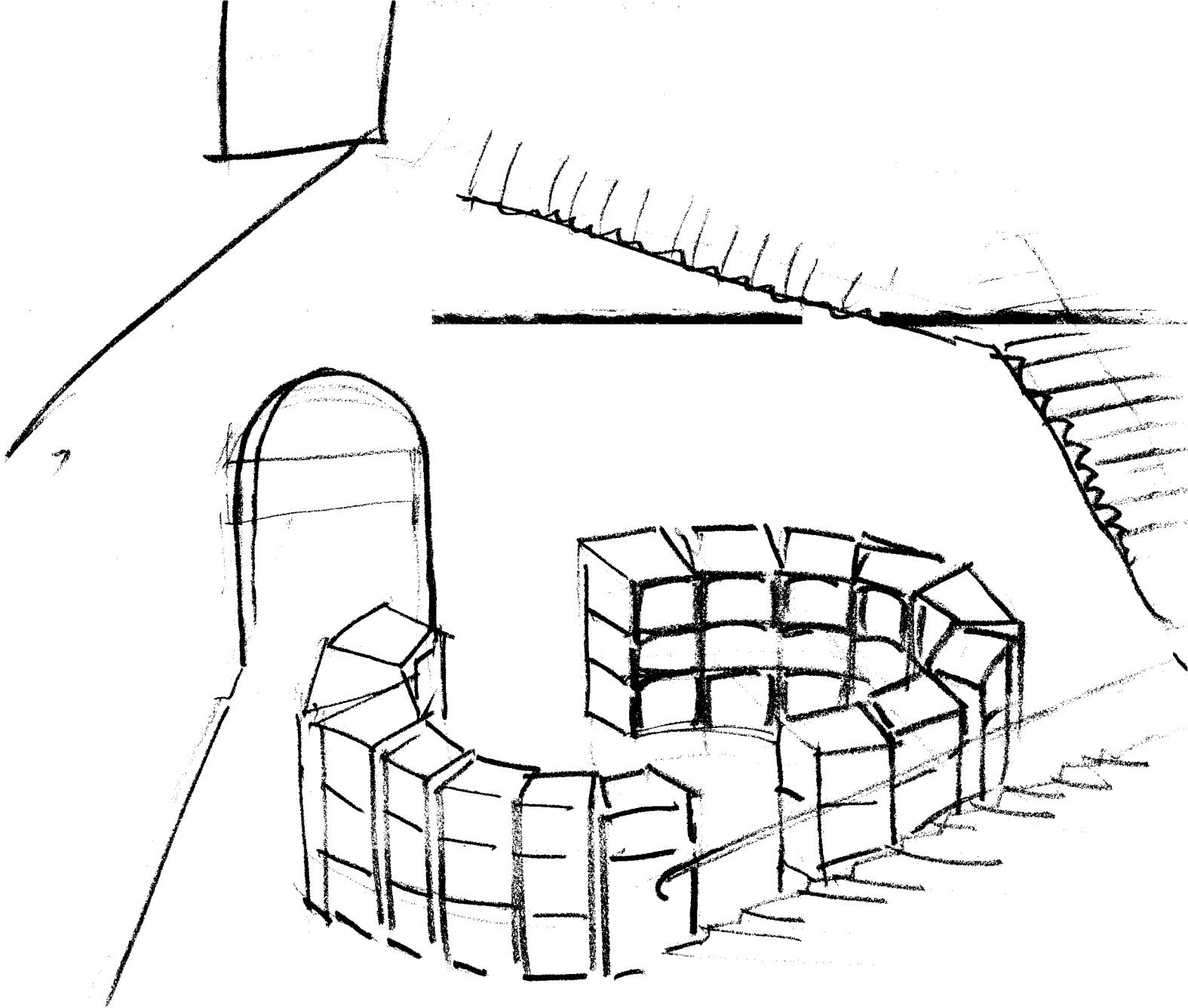

THE WEST
(PRELIMINARY DESIGN)

THE WEST

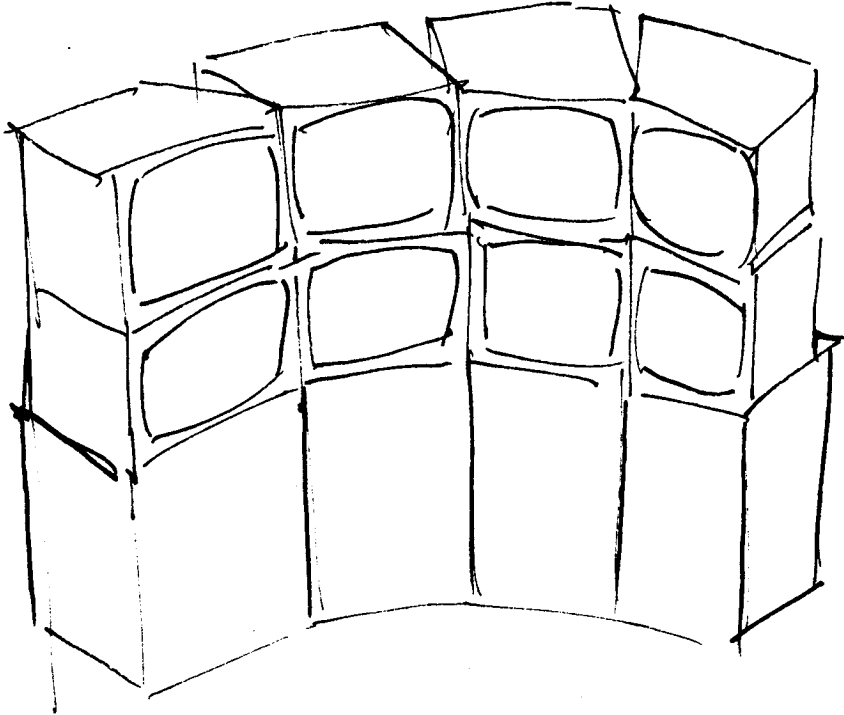
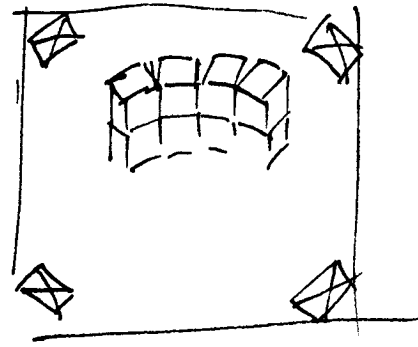

STACK MONITORS AS
CLOSE TO EACH OTHER
AS POSSIBLE

